

## **D3CM160409052014\_Generic**

# **D3CM1604 DOCSIS 3.0 Cable Modem Administrator Manual**

### **FastFind Links**

**Getting to Know the Cable Modem**

**Installing the Cable Modem**

**Preconfiguration Guidelines**

**Configuring the Cable Modem**

SMC Networks  
20 Mason  
Irvine, CA. 92618  
U.S.A.

Copyright © 2014 SMC Networks  
All Rights Reserved

Information furnished by SMC Networks, Inc. (SMC) is believed to be accurate and reliable. However, no responsibility is assumed by SMC for its use, or for any infringements of patents or other rights of third parties which may result from its use. No license is granted by implication or otherwise under any patent or patent rights of SMC. SMC reserves the right to change specifications at any time without notice

No part of this publication may be reproduced or transmitted in any form or by any means, electronic or mechanical, including photocopying and recording, or stored in a database or retrieval system for any purpose without the express written permission of SMC.

Microsoft and Windows are registered trademarks of Microsoft Corporation. Apple and Macintosh are registered trademarks of Apple, Inc. All other brands, product names, trademarks, or service marks are property of their respective owners.

This product (Models: D3CM1604) includes software code developed by third parties, including software code subject to the GNU General Public License ("GPL") or GNU Lesser General Public License (LGPL). As applicable, the terms of the GPL and LGPL, and information on obtaining access to the GPL code and LGPL used in this product, are available to you at <http://gpl.smc.com/>. The GPL code and LGPL code used in this product is distributed WITHOUT ANY WARRANTY and is subject to the copyrights of one or more authors. For details, see the GPL Code and LGPL Code for this product and the terms of the GPL and LGPL.

# Contents

Important Safety Instructions .....	v
<b>Preface.....</b>	<b>vii</b>
Key Features .....	viii
Document Organization .....	viii
Document Conventions .....	ix
Safety and Warnings.....	ix
Typographic Conventions .....	ix
<b>1 Getting to Know the Cable Modem .....</b>	<b>10</b>
Unpacking Package Contents.....	11
System Requirements .....	11
Quick Installation Overview.....	11
Front Panel .....	13
Rear Panel .....	15
Using the Reset Button.....	16
<b>2 Installing the Cable Modem .....</b>	<b>17</b>
Finding a Suitable Location.....	18
Connecting to the LAN.....	19
Connecting the WAN .....	20
Powering on the Cable Modem.....	20
<b>3 Preconfiguration Guidelines.....</b>	<b>21</b>
Configuring Your Computer for TCP/IP.....	22
Configuring Microsoft Windows 2000 .....	22
Configuring Microsoft Windows XP .....	23
Configuring Microsoft Windows Vista .....	24
Configuring Microsoft Windows 7 .....	27
Configuring an Apple® Macintosh® Computer.....	30
Disabling Proxy Settings.....	31
Disabling Proxy Settings in Internet Explorer .....	31
Disabling Proxy Settings in Firefox.....	31
Disabling Proxy Settings in Safari .....	32
Disabling Firewall and Security Software .....	32
Confirming the Cable Modem’s Online Status.....	32
Confirming Your Computer’s Link Status .....	32

<b>4 Configuring the Cable Modem.....</b>	<b>33</b>
Accessing the Cable Modem 's Web Management .....	34
Understanding the Web Management Interface .....	35
Web Management Interface Menus .....	35
Viewing System Software Settings .....	36
Viewing Network Connectivity .....	37
Configuring Security Settings .....	39
Viewing the Event Log.....	40
<b>5 Troubleshooting Procedures.....</b>	<b>41</b>
Basic Troubleshooting Procedures .....	42
Advanced Troubleshooting Procedures .....	43
Troubleshooting Physical Network Problems .....	43
Troubleshooting Configuration Problems .....	44
Determining Your IP Address .....	44
Troubleshooting Software-Interaction Problems.....	48
Specific Troubleshooting Procedures.....	49
Cannot Log In to .....	49
Local Networked Devices Cannot Access the Cable Modem .....	49
Cannot Access the Internet.....	50
Cannot Access Networked Devices .....	51
Using the Ping Utility to Troubleshoot .....	51
Testing the Path from a Computer to the Cable Modem.....	52
Testing the Path from a Computer to the Internet.....	52
Using Ping on a Macintosh.....	53
Disconnects from the Internet .....	54
Slow Web Browsing .....	54
Cannot Configure Port Forwarding.....	55
Cable Modem is Not Passing DHCP Address to a computer .....	55
Determining a Computer's MAC Address.....	55
Microsoft Windows .....	55
Apple Macintosh Windows OS X.....	56
<b>Appendix A - Glossary .....</b>	<b>57</b>
<b>Appendix B - Compliance .....</b>	<b>58</b>
<b>Index .....</b>	<b>60</b>

## Important Safety Instructions

### **Read these instructions before you begin.**

When using your equipment, basic safety precautions should always be followed to reduce the risk of fire, electric shock, and injury to persons, including the following:

- Y Read and follow all instructions.
- Y Keep these instructions.
- Y Heed all warnings.
- Y Only use attachments/accessories specified by the manufacturer.
- Y Do not use this product near water.
- Y Do not install near any heat sources.
- Y Clean only with a dry cloth.
- Y Do not block any ventilation openings.
- Y Use only with the cart, stand, tripod, bracket, or table specified by the manufacturer, or sold with the apparatus.
- Y Unplug this apparatus during lightning storms or when unused for long periods of time.
- Y Refer all servicing to qualified service personnel. Servicing is required when the apparatus has been damaged in any way, such as a power-supply cord or plug is damaged, liquid has been spilled or objects have fallen into the apparatus, the apparatus has been exposed to rain or moisture, does not operate normally, or has been dropped.
- Y Do not alter or disable the polarized or grounding type (three-pronged) plug.
- Y Protect the power cord from being walked on or pinched particularly at plugs, convenience receptacles, and the point where they exit from the apparatus.

This SMC Data Modem complies with applicable requirements for performance, construction, labeling, and information when used in accordance with the instructions below:

---



**Warning: Risk of shock**

Mains voltages inside this unit. No user serviceable parts inside. Refer service to qualified personnel only!

---



**CAUTION: Potential equipment damage Potential loss of service**

Connection of the Data Modem to existing wiring should be performed only by a professional installer. Failure to do so may result in loss of service and/or permanent damage to the Data Modem.

---

- Y Do not use product near water (i.e. wet basement, bathtub, sink or near a swimming pool, etc.), to avoid risk of electrocution.
- Y Avoid using and/or connecting the equipment during an electrical storm, to avoid risk of electrocution.
- Y Do not locate the equipment within 6 feet (1.9m) of a flame or ignition source (i.e. heat registers, space heaters, fireplaces, etc.).
- Y Only use power supply and power cord included with the equipment.
- Y Equipment should be installed near the power outlet and should be easily accessible.
- Y The shield of the coaxial cable must be connected to earth (Grounded) at the entrance to the building in accordance with applicable national electrical installation codes. In the U.S., this is required by NFPA 70 (National Electrical Code) Article 820. In the European Union and in certain other countries, CATV installation equipment bonding requirements are specified in IEC 60728-11, Cable networks for television signals, sound signals and interactive service, Part 11: Safety. This equipment is intended to be installed in accordance with the requirements of IEC 60728-11 for safe operation.
- Y In areas of high surge events or poor grounding situations and areas prone to lightning strikes, additional surge protection may be required on the AC, RFM Ethernet and Phones lines.

## Preface

The SMC D3CM1604 Cable Modem is an ideal all-in-one wired solution for home and business environments. SMC is proud to provide a powerful, yet simple communication device for connecting your local-area network (LAN) to the Internet.

This Administrator Manual contains all the information you need to install and configure your new D3CM1604 Cable Modem.



## Key Features

The following list summarizes the cable modem's key features.

- Y CableLabs-compliant 3.0 cable modem featuring 16 downstream and 4 upstream high-speed data channels.
- Y One 10/100/1000 Mbps auto-sensing LAN port with auto-MDI/MDIX.
- Y Dynamic Host Configuration Protocol (DHCP) for dynamic IP configuration, and Domain Name System (DNS) for domain name mapping.
- Y Advanced SPI firewall for enhanced network security from attacks over the Internet:
  - Firewall protection with Stateful Packet Inspection
  - Client privileges
  - Hacker prevention
  - Protection from denial of service (DoS) attacks
  - Network Address Translation (NAT)
- Y Effortless plug-and-play installation.
- Y Intuitive graphical user interface (GUI) configuration, regardless of operating system.
- Y Comprehensive front panel LEDs for network status and troubleshooting.
- Y Compatible with all popular Internet applications.

## Document Organization

This document consists of five chapters and two appendixes.

- Y **Chapter 1** – describes the contents in the package and system requirements. It also provides an overview of the cable modem's front, rear, top, and bottom panels.
- Y **Chapter 2** – describes how to install the cable modem.
- Y **Chapter 3** – describes how to configure TCP/IP settings on the computer you will use to configure the cable modem.
- Y **Chapter 4** – describes how to configure the cable modem.
- Y **Chapter 5** – provides troubleshooting information you can use in the unlikely event you encounter a problem with the cable modem.
- Y **Appendix A** - is a glossary that defines the technical terms in this document.
- Y **Appendix B** - contains compliance information.







## Document Conventions

This document uses the following conventions to draw your attention to certain information.

### Safety and Warnings

This document uses the following symbols to draw your attention to certain information.

Symbol	Meaning	Description
	Note	Notes emphasize or supplement important points of the main text.
	Tip	Tips provide helpful information, guidelines, or suggestions for performing tasks more effectively.
	Warning	Warnings indicate that failure to take a specified action could result in damage to the device.
	Electric Shock Hazard	This symbol warns users of electric shock hazard. Failure to take appropriate precautions such as not opening or touching hazardous areas of the equipment could result in injury or death.

## Typographic Conventions

This document also uses the following typographic conventions.

Convention	Description
<b>Bold</b>	Indicates text on a window, other than the window title, including menus, menu options, buttons, fields, and labels.
<i>Italic</i>	Indicates a variable, which is a placeholder for actual text provided by the user or system. Angled brackets (< >) are also used to indicate variables.
screen/code	Indicates text that is displayed on screen or entered by the user.
< > angled brackets	Indicates a variable, which is a placeholder for actual text provided by the user or system. Italic font is also used to indicate variables.
[ ] square brackets	Indicates optional values.
{ } braces	Indicates required or expected values.
vertical bar	Indicates that you have a choice between two or more options or arguments.

# 1 Getting to Know the Cable Modem

Before you install your D3CM1604 Cable Modem, check the package contents and become familiar with the 's front and back panels.

The topics covered in this chapter are:

- Y Unpacking Package Contents (page 11)
- Y System Requirements (page 11)
- Y Front Panel (page 13)
- Y Rear Panel (page 14)
- Y Using the Reset Button (page 16)

## Unpacking Package Contents

Unpack the items in your D3CM1604 Cable Modem contents and confirm that no items are missing or damaged. Your package should include:

- Y One D3CM1604 Cable Modem
- Y One Category 5E Ethernet cable
- Y One power supply
- Y One set of quick-installation instructions

If any items are missing or damaged, please contact your cable service provider. Keep the carton, including the original packing material, in case you need to store the product or return it.

## System Requirements

To complete your installation, you need the following items:

- Y Provisioned Internet access on a cable network that supports cable modem service.
- Y A computer with a wired network adapter with TCP/IP installed.
- Y A Java-enabled Web browser, such as Microsoft Internet Explorer 5.5 or above.
- Y Microsoft® Windows® 2000 or higher for USB driver support.

## Quick Installation Overview

1. Connect the coaxial cable from the cable outlet to the cable modem.
2. Connect your wired (Ethernet) connections to the rear panel, as shown in Figure 1-1.

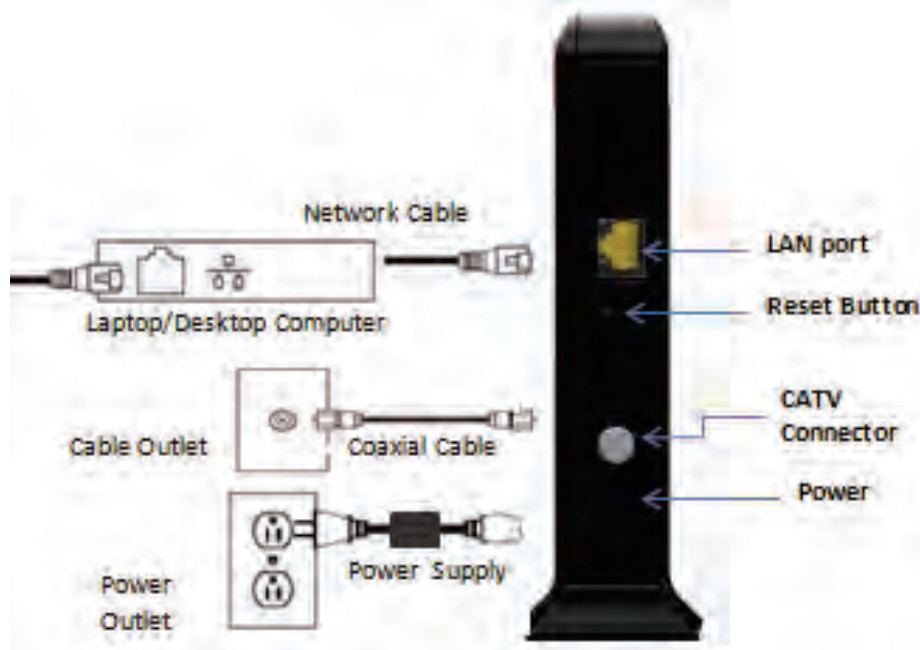

**Figure 1-1. Hardware Connections**

3. Connect the power cord to the cable modem and to a wall power outlet.



**WARNING:** Use only the supplied power cord! Using a different power cord may damage your unit and void the warranty.

---

4. Confirm that the front panel **POWER** LED goes ON.
5. Wait until the **DS**, **US**, and **ONLINE** LEDs stop flashing and the **ONLINE** LED stays ON, indicating that the device is online. If the **ONLINE** LED does not go ON in 5 minutes, contact your Internet Service Provider.
6. (Optional): Log in to the D3CM1604 to configure additional device settings.
  - a. Open a Web browser page and type <http://192.168.100.1> in the address bar.
  - b. At the Login screen, enter the following case-sensitive login information:
    - username: MSO
    - password: changeme

## Front Panel





The front panel of your D3CM1604 Cable Modem contains a set of light-emitting diode (LED) indicators. These LEDs show the status of the cable modem and simplify troubleshooting.

Figure 1-2 shows the front panel of the D3CM1604 Cable Modem. Table 1-1 describes the front panel LEDs.



**Figure 1-2. Front Panel of the D3CM1604 Cable Modem**

**Table 1-1. Front Panel LEDs**

Symbol	LED	Color	Description
	POWER	—	OFF = DC power is not supplied to the cable modem.
		Green	ON = DC power is supplied to the and power switch is in the ON position.
	DS	Blue	Blinking = scanning for downstream channel. ON = locked on DOCSIS 3.0 downstream channel. OFF = no power.
		Green	On = locked on DOCSIS 2.0 downstream channel.
	US	Blue	Blinking = ranging is in progress. ON = ranging is complete, DOCSIS 3.0 bonded upstream. OFF = no power or not locked on upstream channel.
		Green	ON = ranging is complete, DOCSIS 2.0 bonded upstream.
	ONLINE	Blue	Blinking = DHCP and registration in progress. ON = online in DOCSIS 3.0 mode. OFF = no power or upstream ranging not complete.
		Green	ON = online in DOCSIS 2.0 mode
	LINK	Blue	Blinking = data activity. ON = Gigabit Ethernet LAN device connected. OFF = no LAN devices connected.
		Green	Blinking = data activity. ON = 10/100 Ethernet LAN device connected.

## Rear Panel

The rear panel of your D3CM1604 Cable Modem contains a reset button and the ports for attaching the supplied power adapter and making additional connections. Figure 1-3 shows the rear panel components and Table 1-2 describes their meanings.

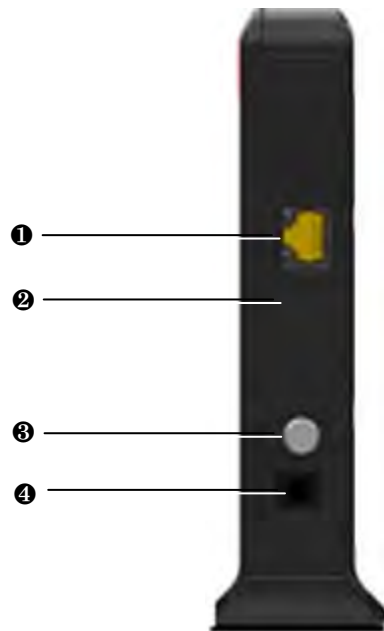

**Figure 1-3. Rear View of the D3CM1604 Cable Modem**

**Table 1-2. D3CM1604 Cable Modem Rear Panel Components**

	Label	Description
❶	LAN	One 10/100/1000 auto-sensing RJ-45 switch port. Connect a device on your LAN such as a computer, hub, or switch to these ports.
❷	RST	Use this button to reset the power or restore the default factory settings (see "Using the Reset Button" on page 16).
❸	CABLE	Connect your coaxial cable line to this port.
❹	POWER	Connect the supplied power cord to this port.

## Using the Reset Button

Using the reset button on the rear panel (see Figure 1-3 on page 15), you can perform two types of reset operations with the cable modem:

- Software reset – power-cycles the cable modem and retains its current configuration settings.
- Factory default reset – removes all overrides made to the cable modem's factory default configuration and returns the cable modem to its original factory default settings.

The number of seconds you press the reset button determines which reset operation is performed. To protect against accidental resets, the reset button is recessed on the cable modem rear panel.



**Note:** You can also reset the cable modem and retain its current configuration settings using the RESET method described under "Configuring Security Settings" on page 39.

To use the reset button to perform a software or factory default reset:

1. Leave power plugged into the cable modem.
2. Find the reset button at the top of the back panel, then use a thin object to press and hold the reset button as follows:
  - To perform a software reset, press the reset button for at least 10 seconds.
  - To perform a factory default reset, press the reset button for at least 15 seconds.
3. Release the reset button.



## 2 Installing the Cable Modem

This chapter describes how to install your D3CM1604 Cable Modem. The topics covered in this chapter are:

- Y Finding a Suitable Location (page 18)
- Y Connecting to the LAN (page 19)
- Y Connecting the WAN (page 20)
- Y Powering on the Cable Modem (page 20)

## Finding a Suitable Location

Your D3CM1604 Cable Modem can be installed in any location with access to the cable network. All cables connect to the rear panel of the cable modem for better organization and utility. The LED indicators on the front panel are easily visible to show network activity and status.

For optimum performance, the location you choose should:

- Y Be close to a working AC power outlet when powering the cable modem using AC power.
- Y Allow at least one foot of space around the sides and top of the cable modem to provide sufficient air flow around the device.
- Y Not expose the cable modem to a dusty or wet environment.
- Y Be an elevated location such as a high shelf, keeping the number of walls and ceilings between the cable modem and your other devices to a minimum.
- Y Be away from electrical devices that are potential sources of interference, such as ceiling fans, home security systems, microwaves, or the base for a cordless phone.
- Y Be away from any large metal surfaces, such as a solid metal door or aluminum studs. Large expanses of other materials such as glass, insulated walls, fish tanks, mirrors, brick, and concrete can also affect your signal.
- Y Should allow the cable modem to connect to an AC outlet that is not controlled by a wall switch.

## Connecting to the LAN

Using an Ethernet LAN cable, you can connect the cable modem to a desktop computer, notebook, hub, or switch. The cable modem supports auto-MDI/MDIX, so you can use either a standard straight-through or crossover Ethernet cable.

1. Connect either end of an Ethernet cable to the **LAN** port on the rear panel of the cable modem (see Figure 2-1).



**Figure 2-1. Connecting to the Ethernet Port on the Cable Modem Rear Panel**

2. Connect the other end of the cable to your computer's network-interface card (NIC) or to another network device (see Figure 2-2).

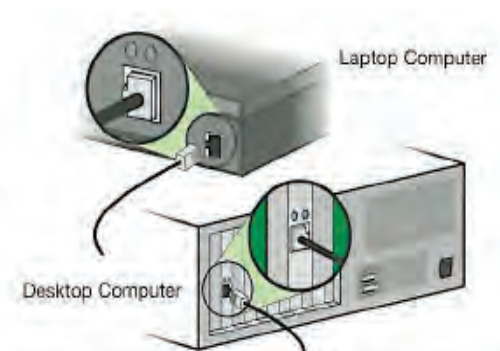

**Figure 2-2. Connecting the Cable Modem to the a Laptop or Desktop Computer**

## Connecting the WAN

To connect the cable modem to a Wide Area Network (WAN) interface:

1. Connect a coaxial cable to the port labeled **CABLE** on the rear panel of the cable modem from a cable port in your home or office (see Figure 1-3 on page 15). Use only manufactured coaxial patch cables with F-type connectors at both ends for all connections.
2. Hand-tighten the connectors to secure the connection.
3. If the modem was not installed by your Internet Service Provider (ISP) or is replacing another cable modem, contact your ISP to register the cable modem. If the modem is not registered with your ISP, it cannot connect to the cable network system.

## Powering on the Cable Modem

After making your connections, use the following procedure to power on the cable modem:

1. Connect the supplied power cord to the power port on the rear panel of the cable modem (see Figure 1-3 on page 15).
2. Connect the other end of the power adapter to a working power outlet. The cable modem powers on automatically, the **POWER** LED on the front panel goes ON, and the other front panel LEDs show the cable modem's status (see "Table 1-1" on page 14).



**WARNING:** Only use the power supply supplied with the cable modem. Using a different power supply can damage the cable modem and void the warranty.

## 3 Preconfiguration Guidelines

After you install your D3CM1604 Cable Modem, use the information in this chapter to configure the TCP/IP settings on the computer that is used to configure the cable modem. This chapter also covers other preconfiguration guidelines you should review before configuring the cable modem.

The topics covered in this chapter are:

- Y Configuring Your Computer for TCP/IP (page 22)
- Y Disabling Proxy Settings (page 31)
- Y Disabling Firewall and Security Software (page 32)
- Y Confirming the Cable Modem's Online Status (page 32)
- Y Confirming Your Computer's Link Status (page 32)

## Configuring Your Computer for TCP/IP

Before you configure the cable modem using its Web management interface, configure TCP/IP settings on the computer that is used to configure the cable modem. The TCP/IP procedure to use depends on the operating system installed on the computer.

- Y For Microsoft Windows 2000, see the procedure below
- Y For Microsoft Windows XP, see page 23
- Y For Microsoft Windows Vista, see page 24
- Y For Microsoft Windows 7, see page 27
- Y For Apple Macintosh, see page 30

### Configuring Microsoft Windows 2000

Use the following procedure to configure your computer if your computer has Microsoft Windows 2000 installed.

1. On the Windows taskbar, click **Start**, point to **Settings**, and then click **Control Panel**.
2. In the Control Panel window, double-click the **Network and Dial-up Connections** icon. If the Ethernet adapter in your computer is installed correctly, the **Local Area Connection** icon appears.
3. Double-click the **Local Area Connection** icon for the Ethernet adapter connected to the . The Local Area Connection Status dialog box appears (see Figure 3-1).

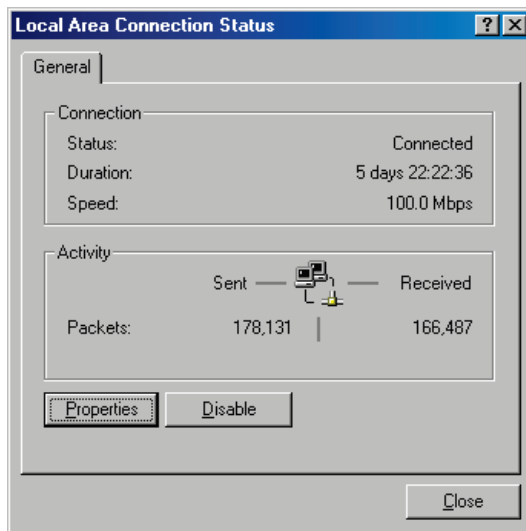

Figure 3-1. Local Area Connection Status Window

4. In the Local Area Connection Status dialog box, click the **Properties** button. The Local Area Connection Properties dialog box appears.
5. In the Local Area Connection Properties dialog box, verify that **Internet Protocol (TCP/IP)** is checked. Then select **Internet Protocol (TCP/IP)** and click the **Properties** button.
6. Click **Obtain an IP address automatically** to configure your computer for DHCP.
7. Click the **OK** button to save this change and close the Local Area Connection Properties dialog box.
8. Click the **OK** button again to save these new changes.
9. Restart your computer.

### Configuring Microsoft Windows XP

Use the following procedure to configure your computer if your computer has Microsoft Windows XP installed. If you use the Classic interface, where the icons and menus resemble previous Windows versions, perform the procedure under “Configuring Microsoft Windows 2000” on page 22.

1. On the Windows taskbar, click **Start**, click **Control Panel**, and then click **Network and Internet Connections**.
2. Click the **Network Connections** icon.
3. Click **Local Area Connection** for the Ethernet adapter connected to the . The Local Area Connection Status dialog box appears.
4. In the Local Area Connection Status dialog box, click the **Properties** button (see Figure 3-2). The Local Area Connection Properties dialog box appears.

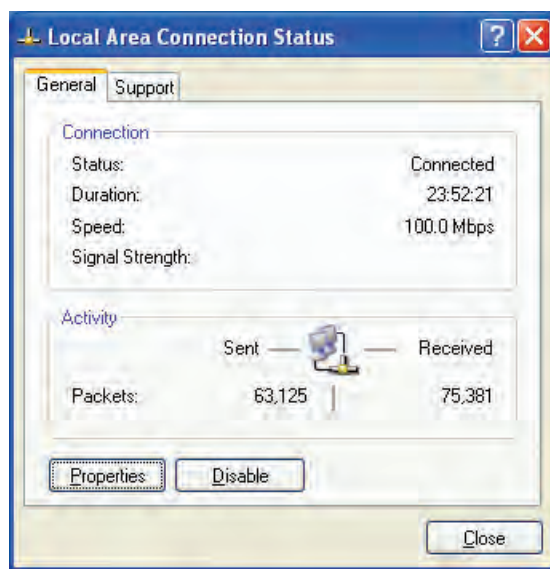

Figure 3-2. Local Area Connection Status Window

5. In the Local Area Connection Properties dialog box, verify that **Internet Protocol (TCP/IP)** is checked. Then select **Internet Protocol (TCP/IP)** and click the **Properties** button. The Internet Protocol (TCP/IP) Properties dialog box appears.
6. In the Internet Protocol (TCP/IP) Properties dialog box, click **Obtain an IP address automatically** to configure your computer for DHCP. Click the **OK** button to save this change and close the Internet Protocol (TCP/IP) Properties dialog box.
7. Click the **OK** button again to save your changes.
8. Restart your computer.

### Configuring Microsoft Windows Vista

Use the following procedure to configure a computer running Microsoft Windows Vista with the default interface. If you use the Classic interface, where the icons and menus resemble previous Windows versions, perform the procedure under “Configuring Microsoft Windows 2000” on page 22.

1. On the Windows taskbar, click **Start**, click **Control Panel**, and then select **Network and Internet** icon.
2. Click **View Networks Status and tasks** and then click **Management Networks Connections**.
3. Right-click the **Local Area Connection** icon and click **Properties**.
4. Click **Continue**. The Local Area Connection Properties dialog box appears.
5. In the Local Area Connection Properties dialog box, verify that **Internet Protocol (TCP/IPv4)** is checked. Then select **Internet Protocol (TCP/IPv4)** and click the **Properties** button (see Figure 3-3). The Internet Protocol Version 4 Properties dialog box appears.



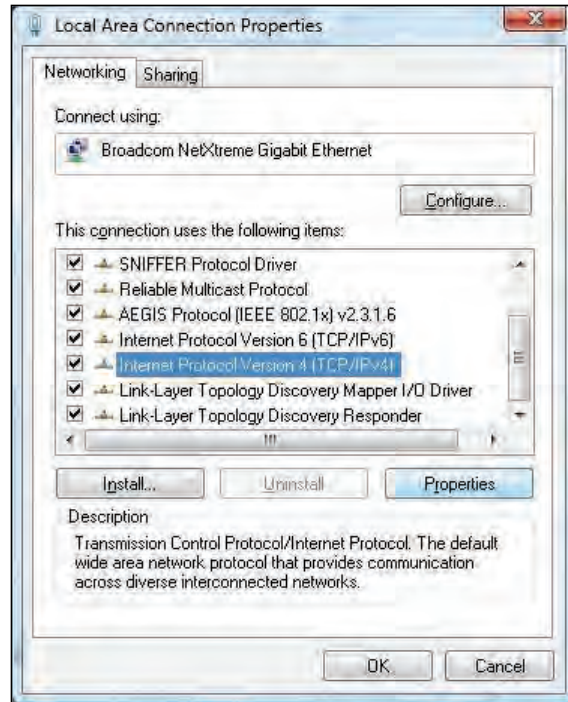

**Figure 3-3. Local Area Connection Properties Window**

6. In the Internet Protocol Version 4 Properties dialog box, click **Obtain an IP address automatically** to configure your computer for DHCP (see Figure 3-4).

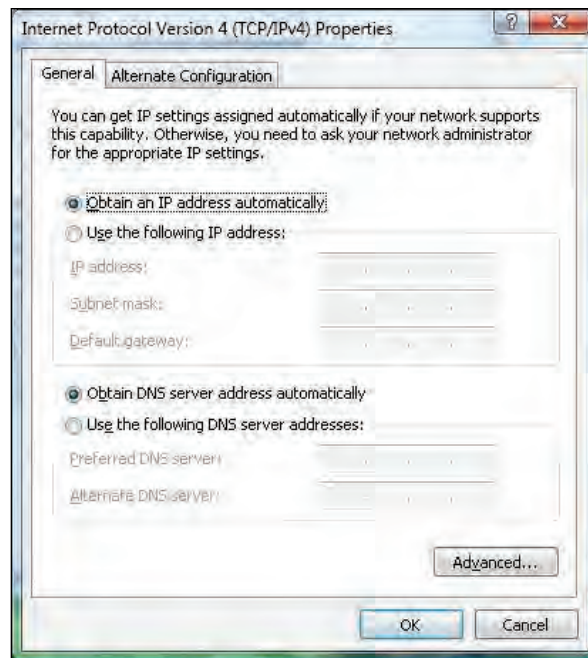

**Figure 3-4. Internet Protocol Properties Window**

7. Click the **OK** button to save your changes and close the dialog box.
8. Click the **OK** button again to save your changes.

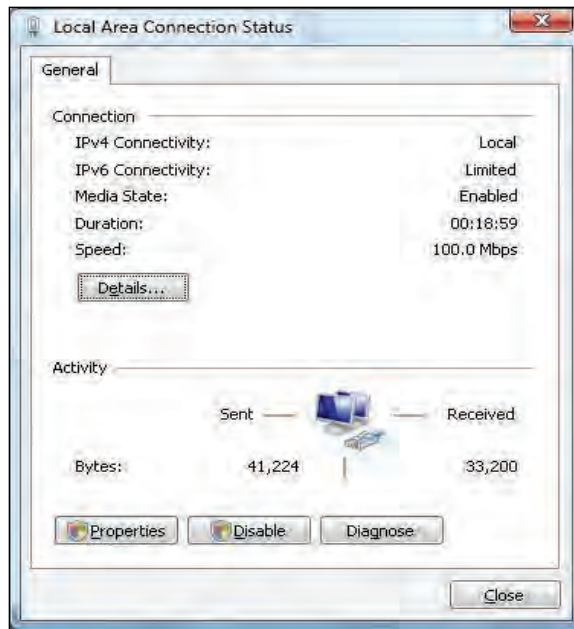
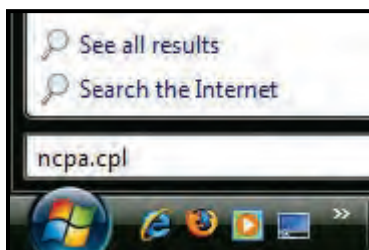

**Figure 3-5. Local Area Connection Status Window**

## Configuring Microsoft Windows 7

Use the following procedure to configure a computer running Microsoft Windows 7.

1. In the Start menu search box, type **ncpa.cpl** and press Enter.



**Figure 3-6. Typing ncpa.cpl in the Start Menu Box**

The Network Connections List appears.

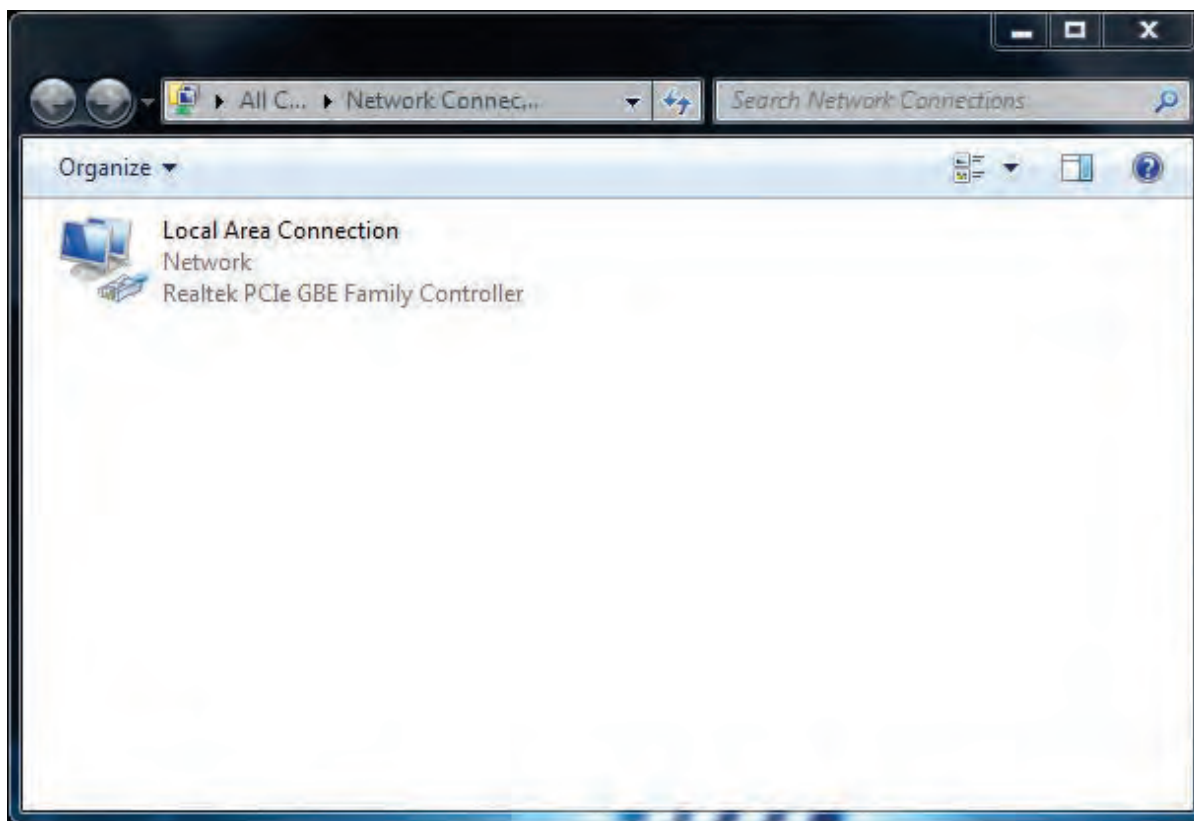

**Figure 3-7. Example of Network Connections List**

2. Right-click the **Local Area Connection** icon and click **Properties**.
3. In the **Networking** tab, click either **Internet Protocol Version 4 (TCP/IPv4)** or **Internet Protocol Version 6 (TCP/IPv6)**, and then click **Properties**.

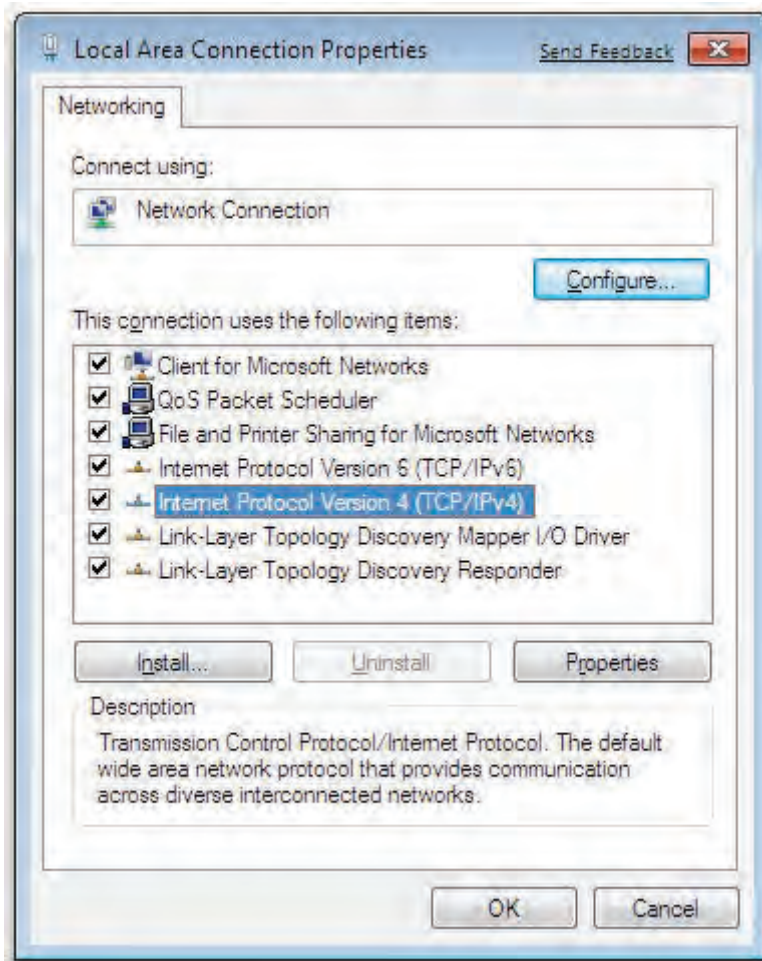

**Figure 3-8. Local Area Network Connection Properties Dialog Box**

4. In the properties dialog box, click **Obtain an IP address automatically** to configure your computer for DHCP (see Figure 3-9).

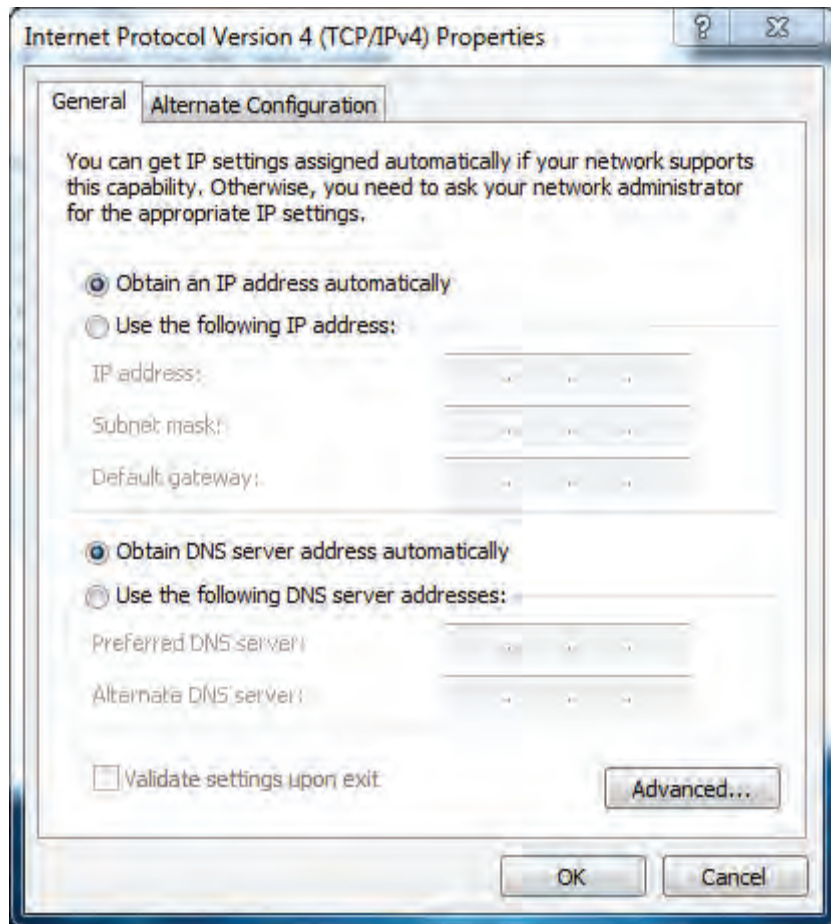

**Figure 3-9. Properties Window**

5. Click the **OK** button to save your changes and close the dialog box.
6. Click the **OK** button again to save your changes.

## Configuring an Apple® Macintosh® Computer

The following procedure describes how to configure TCP/IP on an Apple Macintosh running Mac OS 10.2. If your Apple Macintosh is running Mac OS 7.x or later, the steps you perform and the screens you see may differ slightly from the following. However, you should still be able to use this procedure as a guide to configuring your Apple Macintosh for TCP/IP.

1. Pull down the Apple Menu, click **System Preferences**, and select **Network**.
2. Verify that the NIC connected to the D3CM1604 is selected in the **Show** field.
3. In the **Configure** field on the **TCP/IP** tab, select **Using DHCP** (see Figure 3-10).
4. Click **Apply Now** to apply your settings and close the TCP/IP dialog box.

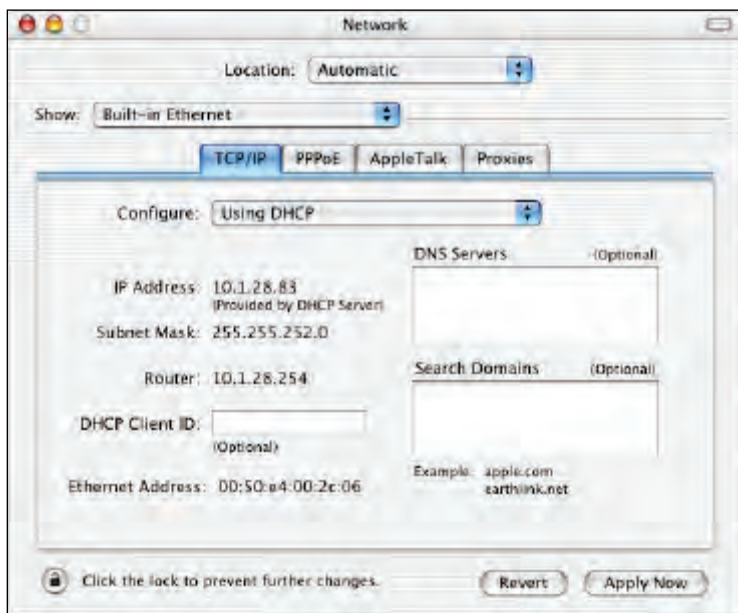

Figure 3-10. Selecting Using DHCP in the Configure Field



## Disabling Proxy Settings

Disable proxy settings in your Web browser. Otherwise, you will not be able to view the 's Web-based configuration pages.

### Disabling Proxy Settings in Internet Explorer

The following procedure describes how to disable proxy settings in Internet Explorer 5 and later.

1. Start Internet Explorer.
2. On your browser's **Tool** menu, click **Options**. The Internet Options dialog box appears.
3. In the Internet Options dialog box, click the **Connections** tab.
4. In the **Connections** tab, click the **LAN settings** button. The Local Area Network (LAN) Settings dialog box appears.
5. In the Local Area Network (LAN) Settings dialog box, uncheck all check boxes.
6. Click **OK** until the Internet Options window appears.
7. In the Internet Options window, under **Temporary Internet Files**, click **Settings**.
8. For the option **Check for newer versions of stored pages**, select **Every time I visit the webpage**.
9. Click **OK** until you close all open browser dialog boxes.

### Disabling Proxy Settings in Firefox

The following procedure describes how to disable proxy settings in Firefox.

1. Start Firefox.
2. On your browser's **Tools** menu, click **Options**. The Options dialog box appears.
3. Click the **Advanced** tab.
4. In the **Advanced** tab, click the **Network** tab.
5. Click the **Settings** button.
6. Click **Direct connection to the Internet**.
7. Click the **OK** button to confirm this change.

## Disabling Proxy Settings in Safari

The following procedure describes how to disable proxy settings in Safari.

1. Start Safari.
2. Click the **Safari** menu and select **Preferences**.
3. Click the **Advanced** tab.
4. In the **Advanced** tab, click the **Change Settings** button.
5. Choose your location from the **Location** list (this is generally **Automatic**).
6. Select **Built-in Ethernet** as your connection method.
7. Click the **Proxies** tab.
8. Be sure each proxy in the list is unchecked.
9. Click **Apply Now** to finish.

## Disabling Firewall and Security Software

Disable any firewall or security software that may be running on your computer. For more information, refer to the documentation for your firewall. After you configure the , please re-enable your computer firewall.

## Confirming the Cable Modem's Online Status

Confirm that the **Online** LED on the cable modem front panel is ON (see Figure 1-2 on page 13). If the LED is OFF, replace the coaxial cable connecting the cable modem to the cable service. If the **Online** LED does not go ON after several minutes, please contact your cable provider to confirm that the service is active.

## Confirming Your Computer's Link Status

Be sure there is an Ethernet cable connecting your computer to the cable modem. Then confirm that the LEDs for the port connected to your computer are blinking. If the LEDs are OFF, the connection between your computer and cable modem is not working properly.



## 4 Configuring the Cable Modem

After configuring your computer for TCP/IP and following the preconfiguration guidelines in Chapter 3, use that computer's Web browser to configure your cable modem. This chapter describes how to use your computer's Web browser to configure the cable modem.

The topics covered in this chapter are:

- Y Accessing the Cable Modem 's Web Management (page 34)
- Y Understanding the Web Management Interface (page 35)
- Y Web Management Interface Menus (page 35)

## Accessing the Cable Modem 's Web Management

After configuring your computer for TCP/IP and reviewing the guidelines on the previous page, configure the cable modem using its Web-based management interface. From your Web browser, log in to the interface to define system parameters, change password settings, view status windows to monitor network conditions, and control the cable modem and its ports.

To display the D3CM1604 Cable Modem's Web-based management screens, use the following procedure.

1. Launch a Web browser.



**Note:** Your computer does not have to be online to configure the cable modem.

2. In the browser address bar, type <http://192.168.100.1> and press the Enter key.
3. When the Login screen appears, enter the default username and default password furnished by SMC Networks. The default login is:
  - Username: MSO
  - Password: changeme

Both are case sensitive. For security, each password character is masked as a dot (•).



**Note:** Your cable modem operator may customize the login password, so please check with your operator for the correct password to use.

4. Click the **LOGIN** button to access the cable modem's Web interface. The Connection page appears, showing information about the status of the cable modem's HFC and IP network connectivity. You can also display this page any time by clicking **Status > Connection** in the menu bar.



**Tip:** For security purposes, we recommend you change the login password after logging in to the Web management interface for the first time (see "Configuring Security Settings" on page 39).

## Understanding the Web Management Interface

The top and left sides of the Web management interface contain a **Status** menu and submenus for selecting pages to configure the cable modem. When you click the **Status** menu at the top, a set of submenus appears at the left side. The configuration settings associated with the currently selected submenu appear in the workspace (see Figure 4-1).

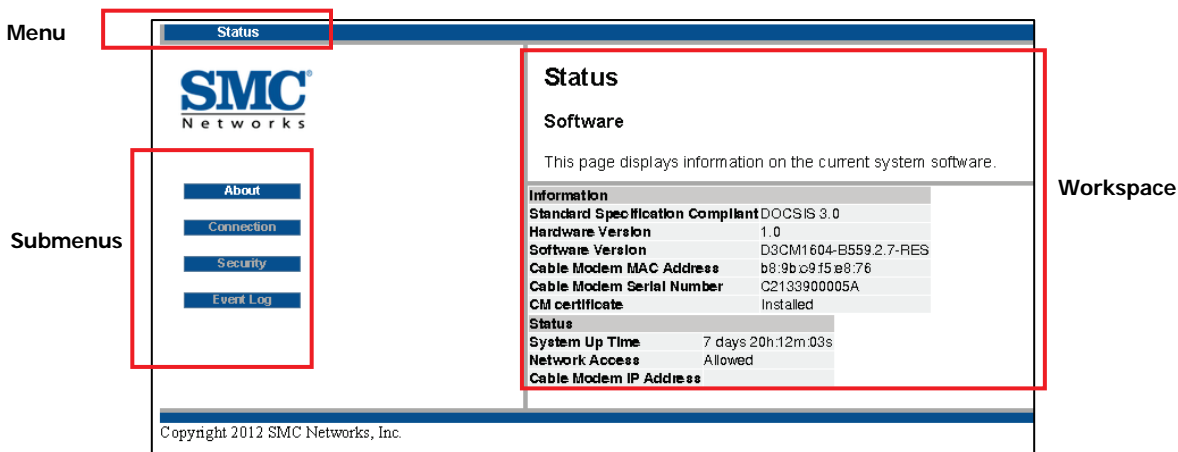

Figure 4-1. Main Areas on the Web Management Interface

## Web Management Interface Menus

Table 4-1 describes the menus in the Web management interface.

Table 4-1. Web Management Interface Menus and Submenus

Menus and Submenus	Description	See Page
Status > About	Shows information about the current system software.	36
Status > Connection	Shows the status of the cable modem's hybrid fibre-coaxial (HFC) and Internet Protocol (IP) network connectivity.	37
Status > Security	Configures administration access privileges and the ability to restore factory defaults to the system.	39
Status > Event Log	Displays the contents of the Simple Network Management Protocol (SNMP) event log.	40

## Viewing System Software Settings

**Path: Status > About**

The Software page shows information about the current system software. The information is organized into the following sections:

Section	Description
Information	Shows the following information: <ul style="list-style-type: none"> <li>• Cable modem's DOCSIS-compliance information (3.0)</li> <li>• Hardware and software versions</li> <li>• Cable modem's Media Access Control (MAC) address, serial number, and certificate</li> </ul>
Status	Shows the following information: <ul style="list-style-type: none"> <li>• How long the cable modem has been operational</li> <li>• Whether network access is allowed</li> <li>• Cable modem's IP address</li> </ul>

### Status

#### Software

This page displays information on the current system software.

Information	
<b>Standard Specification Compliant</b>	DOCSIS 3.0
<b>Hardware Version</b>	1.0
<b>Software Version</b>	D3CM1604-B559.2.7-RES
<b>Cable Modem MAC Address</b>	b8:9b:c9:f5:e8:76
<b>Cable Modem Serial Number</b>	C2133900005A
<b>CM certificate</b>	Installed

Status	
<b>System Up Time</b>	7 days 20h:19m:01s
<b>Network Access</b>	Allowed
<b>Cable Modem IP Address</b>	

## Viewing Network Connectivity

### Path: Status > Connection

The Connection page shows information about the status of the cable modem's HFC and IP network connectivity. The information is organized into the following sections:

Section	Description
Startup Procedure	Shows the procedures performed by the cable modem at startup, their status, and any comment associated with the procedures.
Downstream Bonded Channels	Shows the channel, lock status, modulation, channel ID, frequency, power, signal-to-noise ratio (SNR), correctables, and per-channel and total uncorrectables.
Upstream Bonded Channels	Shows the channel, lock status, upstream (US) channel type, channel ID, symbol rate, frequency, and power.
CM IP Address	Shows the cable modem IP address duration and expiration date/time.
Frequency Select (DS1)	Lets you enter the frequency, in MHz, to be used for communications over downstream channel 1 (DS1). Click <b>TUNE</b> to apply your setting.
Current System Time	Shows the current date and time.

## Status

### Connection

This page displays information on the status of the cable modem's HFC and IP network connectivity.

#### Startup Procedure

Procedure	Status	Comment
Acquire Downstream Channel	723000000 Hz	Locked
Connectivity State	OK	Operational
Boot State	OK	Operational
Configuration File	OK	basic-3_0-smccvc-1312.cfg
Security	Disabled	Disabled

#### Downstream Bonded Channels

Channel	Lock Status	Modulation	Channel ID	Frequency	Power	SNR	Correctables	Uncorrectables
1	Locked	QAM256	8	723000000 Hz	-12.5 dBmV	38.1 dB	70	11
2	Locked	QAM256	9	621000000 Hz	-9.9 dBmV	40.3 dB	0	0
3	Locked	QAM256	10	627000000 Hz	-10.3 dBmV	40.3 dB	0	0
4	Locked	QAM256	11	633000000 Hz	-10.7 dBmV	40.1 dB	0	0
5	Locked	QAM256	12	639000000 Hz	-10.9 dBmV	40.0 dB	0	0
6	Locked	QAM256	13	645000000 Hz	-10.3 dBmV	40.2 dB	0	0
7	Locked	QAM256	14	657000000 Hz	-10.0 dBmV	40.2 dB	0	0
8	Locked	QAM256	15	663000000 Hz	-10.0 dBmV	40.2 dB	0	0
9	Locked	QAM256	16	669000000 Hz	-10.1 dBmV	40.1 dB	0	0
10	Locked	QAM256	1	675000000 Hz	-7.6 dBmV	40.8 dB	0	0
11	Locked	QAM256	2	681000000 Hz	-7.8 dBmV	41.9 dB	0	0
12	Locked	QAM256	3	687000000 Hz	-8.0 dBmV	41.7 dB	0	0
13	Locked	QAM256	4	693000000 Hz	-8.2 dBmV	41.3 dB	0	0
14	Locked	QAM256	5	705000000 Hz	-12.3 dBmV	38.7 dB	268	77
15	Locked	QAM256	6	711000000 Hz	-12.3 dBmV	38.6 dB	5180	6779
16	Locked	QAM256	7	717000000 Hz	-12.4 dBmV	38.4 dB	0	0

Total Correctables	Total Uncorrectables
5518	6867

#### Upstream Bonded Channels

Channel	Lock Status	US Channel Type	Channel ID	Symbol Rate	Frequency	Power
1	Locked	ATDMA	21	5120 Ksym/sec	10000000 Hz	40.5 dBmV
2	Locked	ATDMA	22	5120 Ksym/sec	20000000 Hz	40.0 dBmV
3	Locked	ATDMA	23	5120 Ksym/sec	30000000 Hz	40.8 dBmV
4	Locked	ATDMA	24	5120 Ksym/sec	38000000 Hz	41.8 dBmV

CM IP Address	Duration	Expires
10.30.15.25	D: 01 H: 00 M: 00 S: 00	Thu Sep 04 08:23:51 2014

Frequency Select (DS 1) (in MHz)

## Configuring Security Settings

**Path: Status > Security**

The Security page lets you change the user ID and password you use to log on to the Web management interface, and restore the cable modem to its factory default settings. After you enter your security settings on this page, click **Apply** to have them take effect.

**Status**

**Security**

This page allows configuration of administration access privileges and the ability to restore factory defaults to the system.

---

Password Change User ID

New Password

Re-Enter New Password

Current User ID Password

Restore Factory Defaults  Yes  No

Option	Description
Password Change User ID	To change your logon user ID, enter the new logon user ID.
New Password	To change your logon password, enter the new case-sensitive password. For security, each typed password character is masked as a dot (●).
Re-Enter New Password	Re-enter the same case-sensitive password you entered in the New Password field. For security, each typed password character is masked as a dot (●).
Current User ID Password	To change your logon user ID, enter your current logon user ID.
Restore Factory Defaults	To restore the cable modem to its factory default settings and discard all overrides you made, click <b>Yes</b> , and then click <b>Apply</b> .

## Viewing the Event Log

Path: **Status > Event Log**

The SNMP Event Log page is a read-only page that shows the contents of the cable modem's SNMP event log. The most current entries appear at the top of the log. A **Clear Log** button at the bottom of the page lets you remove all entries from the log.



**Note:** Clicking the **Clear Log** button deletes all log entries without first displaying a precautionary message. Therefore, be sure you do not need the log entries before you click **Clear Log**.

Status		
SNMP Event Log		
This page displays the contents of the SNMP event log.		
Time	Priority	Description
Wed Sep 03 08:23:51 2014	Error (4)	DHCP RENEW WARNING - Field invalid in response via option ;CM-M...
Time Not Established	Warning (3)	DHCP WARNING - Non-critical field invalid in response ;CM-MAC...
Time Not Established	Notice (5)	Honoring MDD; IP provisioning mode = IPv4
Time Not Established	Critical (3)	SYNC Timing Synchronization failure - Failed to acquire FEC f...
Time Not Established	Critical (3)	SYNC Timing Synchronization failure - Failed to acquire QAM/Q...
Time Not Established	Critical (3)	No Ranging Response received - T3 time-out;CM-MAC=b8:9b:c9:f5...
Time Not Established	Warning (5)	B-INIT-RNG Failure - Retries exceeded;CM-MAC=b8:9b:c9:f5:e8:7...
Time Not Established	Critical (3)	No Ranging Response received - T3 time-out;CM-MAC=b8:9b:c9:f5...
Time Not Established	Critical (3)	SYNC Timing Synchronization failure - Failed to acquire QAM/Q...
Time Not Established	Critical (3)	No Ranging Response received - T3 time-out;CM-MAC=b8:9b:c9:f5...
Time Not Established	Critical (3)	SYNC Timing Synchronization failure - Failed to acquire QAM/Q...
Time Not Established	Critical (3)	No Ranging Response received - T3 time-out;CM-MAC=b8:9b:c9:f5...
Time Not Established	Critical (3)	SYNC Timing Synchronization failure - Failed to acquire QAM/Q...
Time Not Established	Critical (3)	No Ranging Response received - T3 time-out;CM-MAC=b8:9b:c9:f5...
Time Not Established	Critical (3)	SYNC Timing Synchronization failure - Failed to acquire QAM/Q...
Fri Aug 15 08:02:13 2014	Critical (3)	Started Unicast Maintenance Ranging - No Response received - ...
Time Not Established	Critical (3)	No Ranging Response received - T3 time-out;CM-MAC=b8:9b:c9:f5...
Wed Aug 13 09:06:14 2014	Critical (3)	Received Response to Broadcast Maintenance Request, But no Un...
Wed Aug 13 09:05:22 2014	Critical (3)	Received Response to Broadcast Maintenance Request, But no Un...
Wed Aug 13 09:04:32 2014	Critical (3)	Received Response to Broadcast Maintenance Request, But no Un...
Wed Aug 13 09:03:43 2014	Critical (3)	Received Response to Broadcast Maintenance Request, But no Un...
Wed Aug 13 09:02:53 2014	Critical (3)	Received Response to Broadcast Maintenance Request, But no Un...
Wed Aug 13 09:01:10 2014	Critical (3)	Received Response to Broadcast Maintenance Request, But no Un...
Tue Jul 01 15:01:32 2014	Critical (3)	SYNC Timing Synchronization failure - Failed to acquire QAM/Q...
Tue Jul 01 14:56:03 2014	Critical (3)	SYNC Timing Synchronization failure - Failed to acquire FEC f...
Tue Jul 01 14:56:01 2014	Critical (3)	Received Response to Broadcast Maintenance Request, But no Un...
Tue Jul 01 14:56:01 2014	Critical (3)	SYNC Timing Synchronization failure - Failed to acquire FEC f...
Tue Jul 01 14:56:00 2014	Critical (3)	Received Response to Broadcast Maintenance Request, But no Un...
Tue Jul 01 14:56:00 2014	Critical (3)	SYNC Timing Synchronization failure - Failed to acquire FEC f...
Tue Jul 01 14:55:51 2014	Critical (3)	Received Response to Broadcast Maintenance Request, But no Un...
Tue Jul 01 14:55:51 2014	Critical (3)	SYNC Timing Synchronization failure - Failed to acquire FEC f...
Tue Jul 01 14:55:43 2014	Critical (3)	SYNC Timing Synchronization failure - Failed to acquire FEC f...
Mon Jun 16 14:25:23 2014	Critical (3)	Received Response to Broadcast Maintenance Request, But no Un...
Mon Jun 16 10:45:44 2014	Critical (3)	Received Response to Broadcast Maintenance Request, But no Un...

Clear Log



## 5 Troubleshooting Procedures

Successful troubleshooting requires a logical, consistent approach that narrows down the source of a problem by ascertaining what is and isn't working until a single cause is identified. This chapter provides suggestions for identifying and resolving problems in the unlikely event you encounter a problem using the cable modem.

The topics covered in this chapter are:

Topic	Subtopics
Basic Troubleshooting Procedures	See page 42
Advanced Troubleshooting Procedures	<ul style="list-style-type: none"> <li>• Troubleshooting Physical Network Problems (page 43)</li> <li>• Troubleshooting Configuration Problems (page 44)</li> <li>• Determining Your IP Address (page 44)</li> <li>• Troubleshooting Software-Interaction Problems (page 48)</li> </ul>
Specific Troubleshooting Procedures	<ul style="list-style-type: none"> <li>• Cannot Log In to (page 49)</li> <li>• Local Networked Devices Cannot Access the (page 49)</li> <li>• Cannot Access the Internet (page 50)</li> <li>• Cannot Access Networked Devices (page 51)</li> <li>• Using the Ping Utility to Troubleshoot (page 51)</li> <li>• Disconnects from the Internet (page 54)</li> <li>• Slow Web Browsing (page 54)</li> <li>• Cannot Configure Port Forwarding (page 55)</li> <li>• Cable Modem is Not Passing DHCP Address to a computer (page 55)</li> <li>• Determining a Computer's MAC Address (page 55)</li> </ul>

## Basic Troubleshooting Procedures

The following covers basic troubleshooting procedures. Carefully review the sections to make sure you follow the recommended procedures.

### Always start your network using the following sequence

1. Unplug the cable modem and any other routers or switches.
2. Shut down connected computers.
3. Plug in the cable modem first and wait for the lights to cycle through the startup routine. This prevents another device from taking the DHCP lease.
4. Plug in any other routers and switches.
5. Start up your computer.

### Check basic Cable Modem functions

After you turn on power to the cable modem, check that the following LED sequences have occurred (and see “Front Panel” on page 13):

1. When power is first applied, verify that the **POWER** LED is ON.
2. After about a minute, verify the statuses of the following LEDs on the front panel of the cable modem (see Figure 1-2 on page 13):
  - ∇ **ONLINE** = ON (cable modem is operational)
  - ∇ **DS** = ON (cable modem is connected to the Internet)
  - ∇ **US** = ON (cable modem is connected to the Internet)

If this behavior does not occur, see Table 5-1. If the incorrect behavior persists, use the Reset button to return the cable modem to its factory default configuration settings (see “Using the Reset Button” on page 16).

**Table 5-1. Checking Basic Cable Modem Functions**

If...	Perform This Procedure
The <b>POWER</b> and other LEDs are OFF.	<ol style="list-style-type: none"> <li>1. Turn off the cable modem and then turn it on again to see whether the problem is resolved.</li> <li>2. Check that you are using the power adapter supplied with the cable modem.</li> <li>3. Be sure the power cord is connected to the cable modem and to a functioning power outlet.</li> <li>4. Plug a working device, such as a lamp, into the power outlet to confirm that the outlet is working.</li> <li>5. Be sure the power outlet is not controlled by a wall switch that can inadvertently remove power from the outlet.</li> </ol>
The <b>DS</b> and <b>US</b> LEDs are OFF.	<ol style="list-style-type: none"> <li>1. Be sure the Ethernet cable connections are secure at the cable modem and at the computer.</li> <li>2. Be sure that power is turned on to the computer connected to the cable modem.</li> <li>3. Be sure you are using the Ethernet cable supplied with the cable modem or one configured similarly to it.</li> </ol>

## Advanced Troubleshooting Procedures

Most advanced troubleshooting procedures fall into one of the following categories:

- Y Physical - an underlying problem with cables, a bad cable modem, or similar hardware problem. See page 43.
- Y Configuration - a problem with the configuration of one or more of network components. See page 44.
- Y Software - a failure of one or more software applications, an undesired interaction between two or more applications, or an undesired application that has been introduced into the network. See page 48.

### Troubleshooting Physical Network Problems

When you experience network troubles, start by checking the physical network devices and connections. These problems are the most easily fixed and include:

- Y Performing a thorough physical inspection of your network.
- Y Checking that all hardware devices, including the cable modem, are plugged in and physically connected to the network.
- Y Making sure you are using the proper network cables (for example, not using a crossover cable with a NIC that requires a straight-through cable).
- Y Making sure all network cables are in good condition and well seated. Often, reseating the cable into a connector is all that is required to ensure a firm connection.

In addition, some operating systems, such as Microsoft Windows XP, show errors, such as when a network cable is unplugged. Figure 5-1, for instance, shows examples of how Microsoft Windows XP shows connection statuses in the Network Connections window. For information about other operating systems, refer to the documentation for those operating systems.

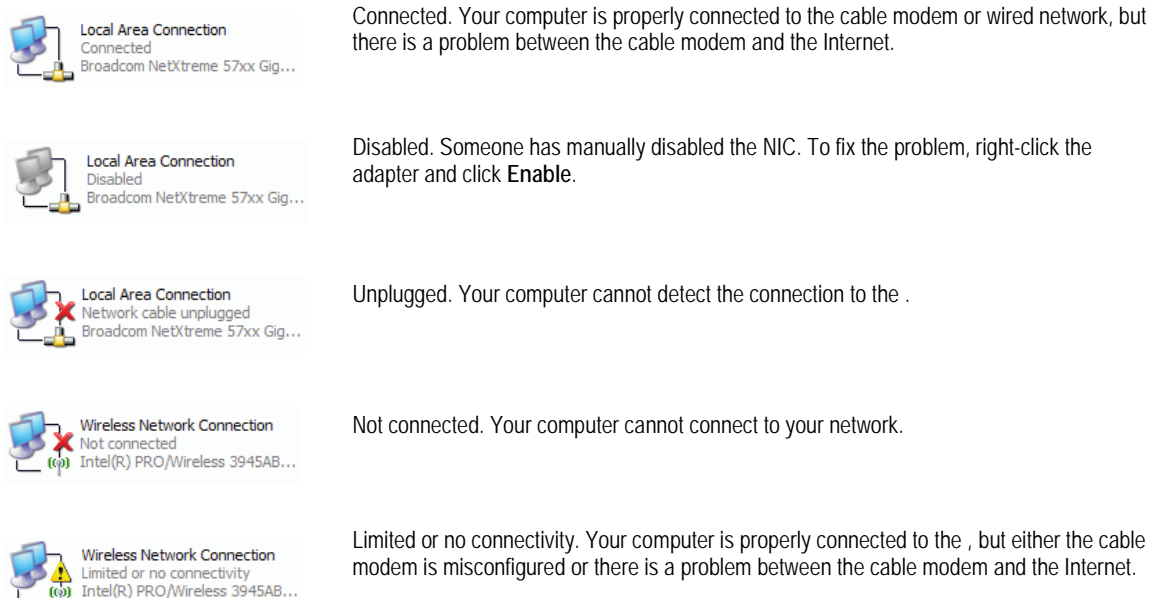

**Figure 5-1. Examples of Connectivity Statuses for Microsoft Windows XP**

## Troubleshooting Configuration Problems

After confirming that your hardware is working properly, examine your networking configuration to determine whether there is a misconfiguration of IP addresses, subnet masks, or broadcast addresses. Common configuration problems can be caused by misconfiguring newly connected or configured devices.

### Determining Your IP Address

An IP address uniquely identifies computers and computing devices, such as the cable modem, on a TCP/IP network. IP addresses are normally expressed in dotted-decimal format, with four numbers (or “octets”) separated by periods, such as **192.168.100.1**.

For troubleshooting purposes, all the numbers in the IP addresses of your networked devices must be consistent across the network. This means:

- Y The first nine numbers (i.e., the first three octets) in the IP addresses are the same for all the devices on the network.

- Y The last three numbers (i.e., the last octet) in the IP addresses are different and not in use by other devices on the network (assuming your subnet mask is 255.255.255.000).

For example, if the IP address for the cable modem is 192.168.100.1, the other devices on the network must have an IP address whose:

- Y First three octets are 192.168.100.
- Y Last octet is any unique number from 0 to 255 (there are restrictions on using 0 and 255, so avoid using them). You would not use 1 as the last number, since that number is the last octet in the cable modem IP address in our example.

Figure 5-2 shows an example of IP addresses assigned to devices on the network.

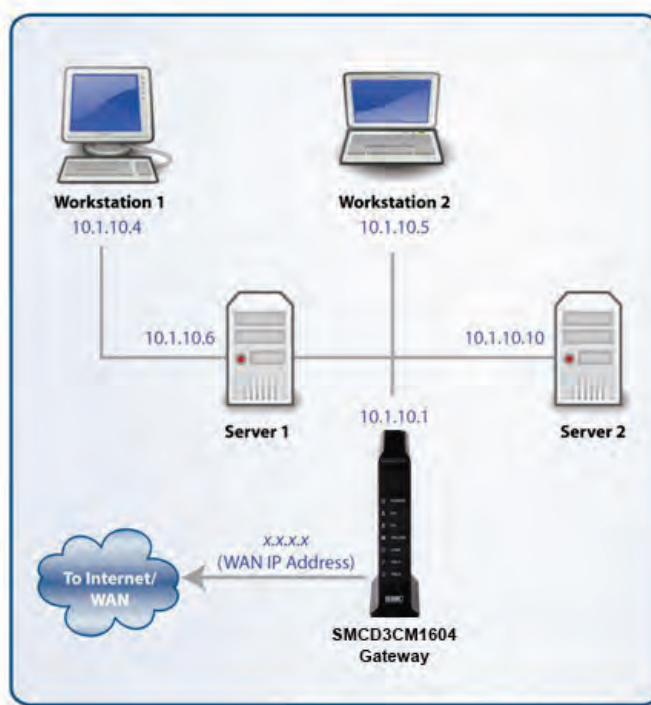

**Figure 5-2. Example of IP Addresses for Networked Devices**

You define the computer's IP address using the procedure appropriate for your operating system, as described in Chapter 3.



**Tip:** The following Windows sections describe how to use the command-line program Windows IP Configuration (ipconfig) to see the IP address of a computer running a Windows operating system. However, if you want even more information, such as IP routing and DHCP information, type **ipconfig /all** instead of **ipconfig** in the Windows sections that follow.

The most common problem associated when viewing IP addresses is that either:

- Y A computer's IP address is not on the same subnet as the other networked devices. In other words, the first nine numbers (three octets) in the device's IP address are not identical to those of the other networked devices.
- Y A computer shows an IP address that starts with the digits **169.254**. When this happens, it often means the computer could not retrieve a network address from a DHCP server and therefore automatically assigned itself an address from the base network address **169.254**. This would be fine if all the computers on your network used IP addresses from the **169.254** base network address. If one of them isn't, however, that computer will have problems connecting to the other network computers.

Possible causes for an IP address not being assigned are:

- Y Defective cables. Replace the cable if it is worn or defective.
- Y An Ethernet cable may not be firmly connected at both ends. Secure the cable at both ends. Often, just reseating the cable into a connector is all that is required.
- Y The NIC may be bad or the network cable connected to it may be the wrong kind (for example, it might be a straight-through cable when a crossover cable is required). If you have another NIC and cable available, try using them instead.
- Y The DHCP server that would automatically assign IP addresses is not configured for DHCP.

The sections that follow describe how to identify the IP addresses on devices running Windows and Macintosh operating systems.

### Microsoft Windows 2000

To find the IP address of a computer running Microsoft Windows 2000:

1. From the Windows task bar, click **Start** and select **Run**.
2. In the **Open** field, type **cmd** and click **OK**. A DOS command window appears.
3. In the DOS command window, type **ipconfig** and then press Enter. Your IP address will be listed (see Figure 5-3).
4. When you finish, type **exit** at the command prompt and press Enter to close the window

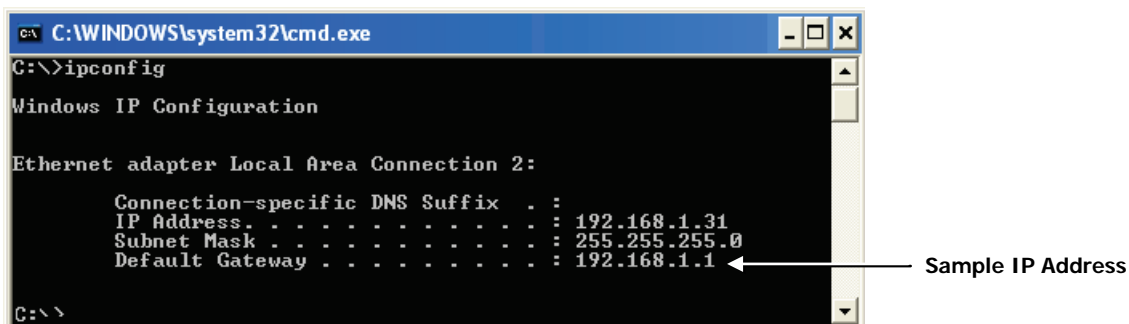

Figure 5-3. Example of an IP Address

### Microsoft Windows XP, Vista, and 7

To find the IP address of a computer running Microsoft Windows XP, Vista, or 7:

1. Click on **Start** and in the Start Search box type **cmd**.
2. Press Enter on your keyboard or click **cmd.exe** in your search list (see Figure 5-4).



Figure 5-4. Example of md.exe in the Search List

3. In the DOS command window, type **ipconfig** and then press Enter. Your IP address will be listed (see Figure 5-3).
4. When you finish, type **exit** at the command prompt and press Enter to close the window.

## Apple Macintosh OS X

To find the IP address of a Mac OS X OS X 10.6 or 10.5 computer:

1. From the Apple menu, select **System Preferences...**
2. In **System Preferences**, from the **View** menu, select **Network**.
3. In the Network preference window, click a network port (for example, **Ethernet**, **AirPort**, **modem**). If you are connected, the IP address appears below **Status**.
4. Close the window when finished.

To find the IP address of a Mac OS X 10.4 or 10.3 computer:

1. From the Apple menu, select **Location**, and then **Network Preferences...**
2. In the Network Preference window, next to **Show**, select **Network Status**. Your network status and IP address appear.
3. Close the window when finished.

## Via the Web

There are various Web sites, such as <http://whatismyipaddress.com/>, that display your IP address and other information about your system. If the page does not display, you may not have a working Internet connection and should try one of the methods described above to find your IP address.

## Troubleshooting Software-Interaction Problems

If the physical network and basic configuration procedures in the preceding sections do not resolve your problem, focus on software problems. The most common software problems are related to firewalls.

Many third-party antivirus programs include built-in firewalls. You may not realize that you installed the firewall component when you installed the antivirus software, and now the firewall may be interfering with your network connectivity.

To troubleshoot software problems:

1. Disconnect your network from the Internet so that you can safely disable any firewalls or antivirus software while you troubleshoot.
2. Disconnect the cable modem from the Internet and unplug the cable modem.
3. After you are off the Internet, disable any antivirus or firewall programs you have, including Internet Connection Firewall or Windows Firewall, on all the computers that have problems. If this step solves the problem, the problem exists with one of these Windows features or products. Enable one at a time and see when things break again. When they do, you know where the problem is and you can either replace that product with one that does not cause problems or change the program's configuration to resolve the problem.



4. When you have everything working, reconnect your devices to the Internet.
5. Restart all your computers.

## Specific Troubleshooting Procedures

The following sections cover specific troubleshooting suggestions you may find helpful if the basic and advanced troubleshooting procedures in the previous sections did not resolve your problem.

### Cannot Log In to

If you are cannot log in to the cable modem's Web management interface:

1. Confirm that the Ethernet cable connecting the computer and cable modem is connected securely at both ends. Often, just reseating the cable into a connector is all that is required.
2. If you have more than one network port available on the cable modem, plug the cable into a different port. If the network connection works, the original port on the cable modem is faulty. However, you can continue to use the other ports.
3. The NIC in your computer might have failed. If possible, connect a different computer to the same network cable. If the connection works, the problem is with the NIC. Contact the NIC manufacturer for support or install a new NIC. If the new computer also fails to connect, replace the Ethernet cable with a new cable, as you might have a faulty cable. If the problem persists, contact technical support for the cable modem supplier.
4. Be sure you are using the correct login information.

### Local Networked Devices Cannot Access the Cable Modem

If devices on the local network cannot access the cable modem:

1. Go to **Status > Connection**.
2. Under the **Startup Procedure**, check for error statuses. If your statuses show no local network connection and/or no clients connected, proceed to the next step.
3. Ping the cable modem from a computer on the same subnet as the cable modem (see "Testing the Path from a Computer to the " on page 52). If the ping fails and there is no firewall software installed, your network configuration, NIC, or cabling is probably at fault.
4. Release and renew the NIC's IP address:
  - a. From the Windows task bar, click **Start** and select **Run**.
  - b. In the **Open** field, type **cmd** and click **OK**.
  - c. At the first command prompt, type **ipconfig/release** and press Enter.
  - d. At the next command prompt, type **ipconfig/renew** and press Enter.

- e. Check whether your computer obtained an IP address other than 169.254.x.x or 0.0.0.0.
5. If the problem continues, power cycle the cable modem and computer:
    - a. Turn off the computer and turn off cable modem.
    - b. Turn on the cable modem and turn on computer.

### Cannot Access the Internet

If the cable modem cannot access the Internet, it could be due to several reasons, such as a failed Internet connection, a misconfigured , or a misconfigured NIC.

1. Unplug the cable modem.



**Note:** If the cable modem is located where you cannot easily unplug it, you can restart it using the Restore / Reboot page (see “Configuring Security Settings” on page 39).

2. Turn off the cable modem for three minutes.
3. Turn off all computers attached to your network.
4. Plug in the cable modem first, turn it on, and let it boot.
5. After the cable modem completes its connection to the ISP, restart your computer.
6. Check that the cable modem’s **ONLINE** LED is ON. If it is OFF, replace the coaxial cable connecting the cable modem to the cable service. If the **ONLINE** LED does not go ON after the cable modem has been powered up for several minutes, contact your cable provider to confirm that the service is active.
7. If the **ONLINE** LED is ON, click **Status > About** and confirm that the **Network** field shows **Active** (see “Viewing System Software Settings” on page 36). If it doesn’t, contact your cable provider to confirm that the service is active.
8. If you have more than one network port available on the cable modem, plug the cable into a different port. If the network connection works, the original port on the cable modem is faulty. However, you can continue to use the other ports.
9. Close any network applications that you might have opened, especially file-sharing and peer-to-peer applications. These applications can consume large amounts of bandwidth that can prevent you from being able to browse the Web.
10. Ping a location on the Internet (see “Testing the Path from a Computer to the Internet” on page 52). For example, `ping www.yahoo.com`. If the ping succeeds, proceed to the next step. If the ping fails:
  - Y Your Web browser may be misconfigured. Be sure you do not have an incorrect proxy server setting in your Web browser.

- Y If your computer is running a Microsoft Windows operating system, check whether the computer has a corrupt winsock registry entry (refer to your Windows documentation).
  - Y The site might be down. Try to ping another site.
  - Y If your additional pings fail, please contact technical support.
11. Check your computer's operating system to see whether the computer has connectivity (for example, see Figure 5-1 and refer to the documentation for your operating system). If it doesn't, try using another computer and NIC attached to the cable modem to connect to the Internet.
  12. Try accessing the Internet with a different browser. If you succeed, the problem exists with the previous browser you used.

### Cannot Access Networked Devices

If you are on a network, but cannot connect to any resources on the network:

1. The Ethernet cable may be worn. Replace the cable if it is worn.
2. The Ethernet cable may not be firmly connected at both ends. Secure the cable at both ends. Often, just reseating the cable into a connector is all that is required.
3. The NIC may be bad or the cable connected to the NIC may be the wrong kind of network cable (for example, you may be using a straight-through cable when a crossover cable is required). If you have another NIC available, try using it instead of the one currently used.
4. Ping the IP address of other computers and devices on your network.
5. For Windows operating systems:
  - Try connecting to a computer on the network using **Start \ Run** and enter **\\PCname**, where **PCname** is the name of the computer to which you want to connect.
  - Add the computer and its IP address to the `LMHOSTS` file. This is a text file that resides in the `Windows\System32\drivers\etc` directory (for Windows2000 or XP) and has the format `IP_Address Computer_Name`.



**Tip:** Browsing is a fairly complicated issue and has a lot of places for failure. If you need to have resources available, create shortcuts on your desktop instead.

### Using the Ping Utility to Troubleshoot

You can use your computer's ping utility to test the path from the computer to the cable modem and from your computer to the Internet.

## Testing the Path from a Computer to the Cable Modem

You can ping the cable modem to verify that the LAN path from your computer to the cable modem is set up correctly. To ping the cable modem from a Windows computer:

1. From the Windows task bar, click **Start** and select Run.
2. In the **Open** field, type **ping** followed by the IP address of the cable modem.
3. Click **OK**. A message similar to the following appears (in this example, 192.168.0.1 is the IP address entered as part of the **ping** command):

```
Pinging 192.168.0.1 with 32 bytes of data
```

If the destination IP address was contacted successfully, a message similar to the following appears:

```
Reply from 192.168.0.1: bytes=32 time=NN ms TTL=xxx
```

If the path was not contacted successfully, a message similar to the following appears:

```
Request timed out
```

If the path is not working properly:

- Y The physical connections may be wrong. Be sure the cable modem's **ONLINE** LED is ON. If it is OFF, review "Basic " on page 42.
- Y Check that the corresponding LEDs on the NIC installed in your computer are ON (refer to the documentation for your NIC). If they are OFF, verify that the Ethernet card driver software and TCP/IP software are both installed and configured properly on your computer.
- Y Verify that the IP addresses for the cable modem and your computer is correct and that both addresses are on the same subnet (for example, 192.168.1.x/255.255.255.0).

## Testing the Path from a Computer to the Internet

After verifying that the path between your computer and cable modem is working properly, use the following procedure to test the path from your computer to the Internet.

To test the path using ping from a Windows PC:

1. From the Windows task bar, click **Start** and select **Run**.
2. In the **Open** field, type **cmd** and click **OK**. A DOS command window appears.
3. At the > prompt, type **ping -n 10 IPaddress** where **IPaddress** is the IP address of a remote device (such as your ISP's server) or Web site (such as www.yahoo.com).
4. Press Enter. If the path is working, a reply similar to the one in the previous section appears. If you do not receive replies:
  - Y Confirm that your computer has the IP address of the cable modem listed as the default . If your computer's IP address is obtained automatically through DHCP, this information

will not be visible in your computer's Control Panel. Verify that the cable modem's IP address is shown as the TCP/IP default.

- Y Check whether your computer's network address (the portion of the IP address specified by the netmask) is different from the network address of the remote device.
5. When you finish, type **exit** at the command prompt and press Enter to close the window.

## Using Ping on a Macintosh

To ping on a Macintosh:

1. Click on **Go > Applications > Utilities**.
2. Click on **Network Utility**, and then click the **Ping** tab. A page similar to the one in Figure 5-5 appears.
3. In the first field, enter the IP address you want to ping.
4. Using the options below the field, select an unlimited number of pings or send a specific number of pings.
5. Click the **Ping** button. If you receive:
  - Y **reply from...**, the destination IP address was contacted successfully.
  - Y **request timed out**, the destination IP address was not contacted successfully.
  - Y **destination host unreachable**, you are not on the same subnet as the destination address. Change your IP address to communicate with the destination address.

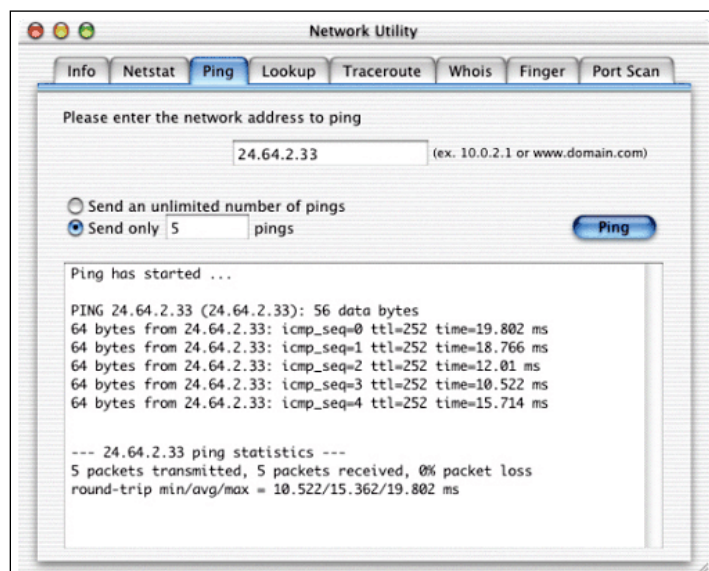

**Figure 5-5. Ping Tab on the Network Utility Page**

## Disconnects from the Internet

If the cable modem has been connected to the Internet for an extended period and holds an IP address (DHCP lease) for a longer period of time than your ISP allows, it is not uncommon for the cable modem to disconnect from the Internet. This is normal and does not indicate any issue with the cable modem.

1. Press the cable modem reset switch.
2. Connect a computer to one of the cable modem's LAN ports.
3. Restart your computer.
4. Reset the cable modem to its factory default settings using either the Reset button (see "Using the Reset Button" on page 16) or the **Restore Factory Defaults** setting on the Security page (see "Configuring Security Settings" on page 39).



**Note:** This step removes all overrides made to the cable modem's default settings and returns the cable modem to its original factory default settings.

In certain network scenarios, it may be helpful to turn off all the equipment on your network, and then turn the equipment all back on. Leaving some devices unplugged for up to five minutes can also help.

### If the disconnections are limited to wired clients only

Check your NIC settings and all cable routing, connections, and power supplies.

### If the disconnections are limited to cable modem clients only

Focus on factors that affect cable modem clients, such as:

- Y Network selection and security
- Y Hardware access control
- Y Client TCP/IP settings
- Y Signal strength
- Y Sources of interference

## Slow Web Browsing

If you experience slow Web browsing with the cable modem:

1. Check for possible intrusions by spyware and viruses.
2. Clear browser settings and cache (refer to the documentation for your Web browser).
3. Stop other programs running in the background that are consuming bandwidth.
4. A specific site may be suffering from server issues. Try another site.

## Cannot Configure Port Forwarding

If you cannot configure port forwarding for software applications, external servers, or gaming:

- Y Ascertain the port(s) that the application or game calls for.
- Y Some ISPs block ports, such as ports 20, 21, and 80. Check with ISP to confirm whether it is blocking ports.
- Y Reserve IP addresses for the computers to ensure they receive the appropriate IP address(es) for the service created.
- Y Disable firewalls and stateful packet inspection (SPI) applications.
- Y Create a dynamic DNS (DynDNS) account for dynamic IP addresses from the ISP.

## Cable Modem is Not Passing DHCP Address to a computer

If the cable modem is not passing DHCP addresses to a computer over a wired or cable connection:

1. Be sure the computer's IP is not statically set already.
2. Release and renew the NIC's IP address:
  - a. From the Windows task bar, click **Start** and select **Run**.
  - b. In the **Open** field, type **cmd** and click **OK**.
  - c. At the first command prompt, type **ipconfig/release** and press Enter.
  - d. At the next command prompt, type **ipconfig/renew** and press Enter.
3. For wired connections, be sure the physical cable connections are correct.

## Determining a Computer's MAC Address

The following sections describe how to obtain a computer's MAC address.

### Microsoft Windows

To determine the MAC address on a Windows computer:

1. From the Windows task bar, click **Start** and select **Run**.
2. In the **Open** field, type **cmd** and click **OK**. A DOS command window appears.
3. In the DOS command window, type **ipconfig/all** and press Enter.
4. This window displays your networking information. The MAC address appears as a **Physical Address** below **Ethernet adapter Local Area Connection**. In the example in Figure 5-6, the MAC address is **00-1E-8C-94-09-EA**, which is the physical address of the NIC card.

- When you finish, type **exit** at the command prompt and press Enter to close the window.

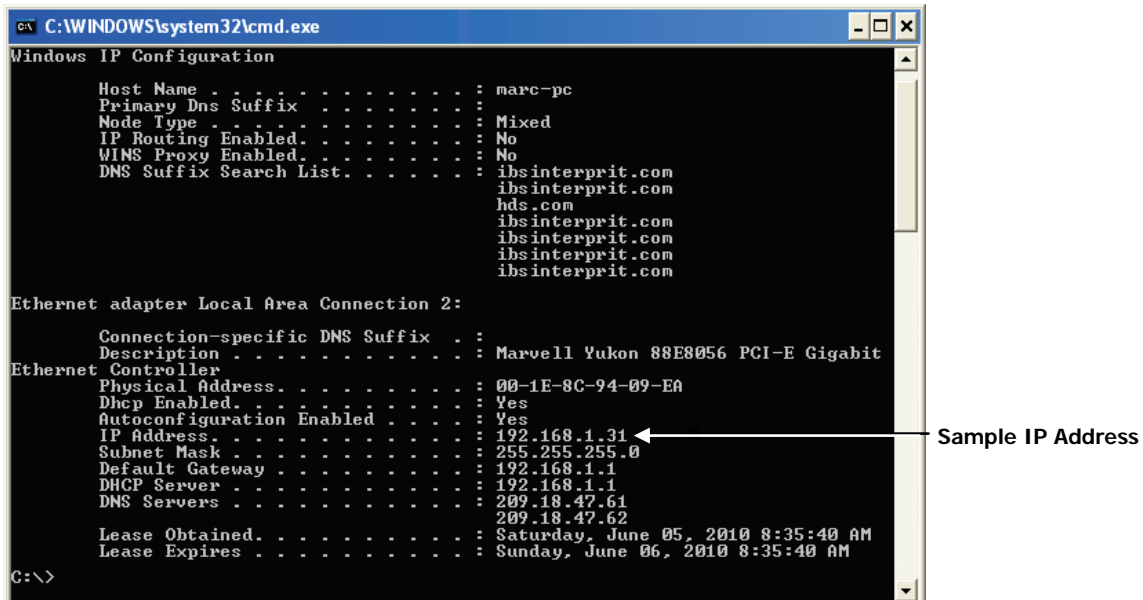

Figure 5-6. Example of MAC Address

### Apple Macintosh Windows OS X

To determine the MAC address on a Mac running OS X, perform the following procedure. The MAC address appears in the form of 00 0D 93 13 51 1A.

- From the dock, select **System Preferences**.
- Select **Network, Select Location, Select Interface**.
- Perform one of the following steps:
  - Y For a wired Mac running Mac OS 10.2 or earlier, select the **TCP/IP** tab. The number next to the **Ethernet Address** is your MAC address.
  - Y For a wired MAX running OS 10.3 and later), select the **Ethernet** tab. The number next to the **Ethernet ID** is your MAC address.
  - Y For a cable modem connection (AirPort), select **AirPort** tab. The number next to the **AirPort ID** is your MAC address.



## Appendix A - Glossary

Term	Definition
Correctables	Number of codewords that were detected to be damaged, but could be repaired by the cable modem.
Downstream	The direction from the head-end toward the subscriber. The downstream channel carries data from the ISP's head end (UBR) to your cable modem.
DS1	Digital Signal 1. A T-carrier signaling method that is widely used standard in telecommunications in North America and Japan to transmit voice and data between devices.
Uncorrectables	Number of codewords that were detected to be damaged beyond possibility of repair by the cable modem. If this count is increasing, the downstream signal conditions are unacceptable, regardless of how good the SNR and power figures look on the Connection page (see "Viewing Network Connectivity" on page 37). Uncorrectables disappear after a reboot because the cable modem resets its counters to zero without store that data permanently in its memory.
Upstream	The direction from the subscriber toward the head-end. The upstream channel carries data from your cable modem to the ISP's head-end.

## Appendix B - Compliance

### FCC Interference Statement

This equipment has been tested and found to comply with the limits for a Class B digital device pursuant to Part 15 of the FCC Rules. These limits are designed to provide reasonable protection against radio interference in a commercial environment. This equipment can generate, use and radiate radio frequency energy and, if not installed and used in accordance with the instructions in this manual, may cause harmful interference to radio communications. Operation of this equipment in a residential area is likely to cause interference, in which case the user, at his own expense, will be required to take whatever measures are necessary to correct the interference. If this equipment does cause harmful interference to radio or television reception, which can be determined by turning the equipment off and on, the user is encouraged to try to correct the interference by one of the following measures:

- Y Reorient or relocate the receiving antenna.
- Y Increase the separation between the equipment and receiver.
- Y Connect the equipment into an outlet on a circuit different from that to which the receiver is connected.
- Y Consult the dealer or an experienced radio/TV technician for help.

The device complies with Part 15 of the FCC Rules. Operation is subject to the following two conditions: (1) This device may not cause harmful interference, and (2) this device must accept any interference received, including interference that may cause undesired operation.

FCC Caution: Any changes or modifications not expressly approved by the party responsible for compliance could void the user's authority to operate this equipment.

IEEE 802.11b or 802.11g operation of this product in the U.S.A is firmware-limited to channels 1 through 11.

#### **IMPORTANT NOTE:**

##### **FCC Radiation Exposure Statement:**

This equipment complies with FCC radiation exposure limits set forth for an uncontrolled environment. This equipment should be installed and operated with minimum distance 20cm between the radiator & your body.

This transmitter must not be co-located or operating in conjunction with any other antenna or transmitter.

The availability of some specific channels and/or operational frequency bands are country dependent and are firmware programmed at the factory to match the intended destination. The firmware setting is not accessible by the end user.

Note to CATV System Installer - This reminder is provided to call the CATV systems installer's attention to Section 820-93 of the National Electric Code which provide guideline for proper grounding and, in particular, specify that the Coaxial cable shield shall be connected to the grounding system of the building, as close to the point of cable entry as practical.

### **FCC Part 68 Statement**

This equipment complies with Part 68 of the FCC Rules. A label is attached to the equipment that contains, among other information, its FCC registration number and ringer equivalence number. If requested, this information must be provided to the telephone company.

This equipment uses the following USOC Jack: RJ-11.

An FCC-compliant telephone cord and modular plug is provided with this equipment. This equipment is designed to be connected to the telephone network or premises wiring using a compatible modular jack, which is FCC Part 68 compliant. Connection to the telephone network should be made by using the standard modular telephone jack.

The REN is useful to determine the quantity of devices that may be connected to the telephone line and still have all of those devices ring when your telephone number is called. In most, but not all areas, the sum of RENs should not exceed 5. To be certain of the number of devices that may be connected to the line, as determined by the total RENs, contact the telephone company to determine the maximum REN for the calling area.

If this equipment causes harm to the telephone network, the telephone company may discontinue your service temporarily. If advance notice is not practical, the telephone company will notify the customer as soon as possible. Also, you will be advised of your right to file a complaint with the FCC if you believe it is necessary.

The telephone company may make changes in its facilities, equipment, operations, or procedures that could affect the operation of the equipment. If this happens, the telephone company will provide advance notice in order for you to make the necessary modifications in order to maintain uninterrupted service.

In the event this equipment should fail to operate properly, disconnect the unit from the telephone line. Try using another FCC approved device in the same telephone jack. If the trouble persists, call the telephone company repair service bureau. If the trouble does not persist and appears to be with this unit, disconnect the unit from the telephone line and discontinue use of the unit until it is repaired. Please note that the telephone company may ask that you disconnect the equipment from the telephone network until the problem has been corrected or until you are sure that the equipment is not malfunctioning.

The user must use the accessories and cables supplied by the manufacturer to get optimum performance from the product.

No repairs may be done by the customer. If trouble is experienced with this equipment, please contact your authorized support provider for repair and warranty information. If the trouble is causing harm to the telephone network, the telephone company may request you remove the equipment from the network until the problem is resolved. This equipment cannot be used on telephone company provided coin service. Connection to Party Line Service is subject to state tariffs.

## Index

### A

- Apple Macintosh
  - IP address, 48
  - MAC address, 56
  - pinging, 53
  - TCP/IP configuration, 30

### B

- Basic setup procedures, 42
- Browsing on Web is slow, 54

### C

- Cable modem
  - compliance, 58
  - configuring, 33
  - connecting to the LAN, 19
  - connecting to the WAN, 20
  - disconnects from the Internet, 54
  - front panel, 13
  - installing, 17
  - key features, viii
  - locating, 18
  - package contents, 11
  - powering on, 20
  - rear panel, 15
  - rebooting and restoring custom settings, 16
  - restoring factory defaults, 16
  - system requirements, 11
  - Web management, 34
- Cannot
  - access cable modem, 49
  - access the Internet, 50
  - configure port forwarding, 55
  - connect to networked devices, 51

- log in to cable modem, 49
- Certificate, 36
- CM IP address, 37
- Compliance, 58
- Configuration, 33
  - TCP/IP, 21, 44
- Connecting
  - LAN, 19
  - WAN, 20
- Conventions in this document, ix
- Current system time, 37

### D

- Determining
  - IP address, 44
  - MAC address, 55
- DHCP
  - address is not passed to computers, 55
  - configuring computers to use, 21
  - ending address, 39
- Disabling
  - firewall, 32
  - proxy settings for Internet Explorer, 31
  - security software, 32
- Disabling proxy settings
  - Firefox, 31
  - Safari, 32
- DOCSIS-compliance information, 36
- Document
  - conventions, ix
  - organization, viii
- Downstream bonded channels, 37

### E

- Event log, 40

- 
- F
- Factory defaults, 39
    - restoring, 16
  - Firefox, disabling proxy settings, 31
  - Firewall, disabling, 32
  - Frequency select, 37
  - Front panel, 13
- H
- Hardware version, 36
  - HFC status, 37
- I
- Installing cable modem, 17
  - Internet
    - cable modem disconnects, 54
    - cannot access, 50
    - testing path from a computer, 52
  - Internet Explorer, disabling proxy settings, 31
  - IP address, 36
    - determining, 44
  - IP status, 37
- K
- Key features, viii
- L
- LAN connection, 19
  - Locating the cable modem, 18
  - Log, 40
  - Logging in to Web management, 34
  - Login password
    - changing, 39
    - entering, 34
- M
- MAC address, 36
    - determining, 55
  - Menus in Web management, 35
  - Microsoft
    - TCP/IP configuration for Windows 2000, 22, 23
    - TCP/IP configuration for Windows 7, 27
    - TCP/IP configuration for Windows Vista, 24
- N
- Network
    - access, 36
    - connectivity, 37
- P
- Package contents, 11
  - Ping, 51
    - from a computer to the cable modem, 52
    - from a computer to the Internet, 52
    - from a Macintosh, 53
  - Port forwarding, 55
  - Powering-on the cable modem, 20
  - Proxy settings, 31
- R
- Rear panel, 15
  - Requirements, 11
  - Restoring factory defaults, 16, 39
- S
- Safari, disabling proxy settings, 32
  - Security
    - page, 39
    - software, 32
  - Serial number, 36
  - Slow Web browsing, 54
  - Software version, 36
  - Startup procedure, 37
  - System
    - requirements, 11
    - software, 36
    - time, 37
    - uptime, 36
- T
- TCP/IP configuration, 21

- Apple Macintosh, 30
  - Microsoft Windows 2000, 22, 23
  - Microsoft Windows 7, 27
  - Microsoft Windows Vista, 24
  - Testing the path from a computer to
    - the Cable modem, 52
    - the Internet, 52
  - Troubleshooting
    - basic setup procedures, 42
    - cable modem disconnects from the Internet, 54
    - cable modem is not passing DHCP to computers, 55
    - cannot access cable modem, 49
    - cannot access the Internet, 50
    - cannot configure port forwarding, 55
    - cannot connect to networked devices, 51
    - cannot log In to cable modem, 49
    - Ping utility, 51
    - Pinging from a Macintosh, 53
    - slow Web browsing, 54
    - testing the path from a computer to the cable modem, 52
    - testing the path from a computer to the Internet, 52
- U
- Upstream bonded channels, 37
  - Uptime, 36
- W
- WAN connection, 20
  - Web browsing is slow, 54
  - Web management
    - logging in, 34
    - menus, 35
  - Web management pages
    - Connection, 37
    - Event Log, 40
    - Security, 39
    - Software, 36



20 Mason  
Irvine, CA. 92618  
U.S.A.  
<http://www.smc.com>